

EUP15AD-1HMC-0 (Product No.:100100071101)

Summary

EUP15AD-1HMC-0 is a 15W AC/DC constant current mode output LED driver featuring the multiple levels selectable by DIP switch, complies with DALI standard protocol IEC 62386, and provides multiple dimming function (DALI, 1-10V active signal, PWM, adjustable resistance, and Touch DIM) to achieve a smooth dimming effect.



Product Features

- Single channel output, output current level selectable by DIP S.W.
- Support a variety of dimming mode (DALI/1-10V active signal/adjustable resistance/PWM/Touch DIM)
- Built-in active PFC function
- Class 2 power supply. Full protective plastic housing
- Dimming effect smooth, no flicker
- Protections: Short circuit, over load, over temperature
- Suitable for indoor LED lighting application, such as down light, spot light, panel light, and so on



Application



Technical Parameters

Model	EUP15AD-1HMC-0																									
Input	Efficiency	>85%@230VAC, Full load																								
	Voltage	220VAC-240VAC																								
	Frequency Range(Hz)	50/60Hz																								
	Power Factor	≥0.95@230VAC, Full load																								
	THD(full load)	<10%@230VAC, Full load																								
	AC Current(max)	0.08Amax@230VAC																								
	Standby power	<0.5W																								
	Inrush Current(max)	Cold start, 18A(twidth=14us measured at 50% Ipeak)@230VAC																								
Output	Current(mA)/Voltage (VDC) Power(W)	350mA/9-40VDC/14W 400mA/9-37VDC/14.8W 450mA/9-33VDC/14.85W 500mA/9-30VDC/15W																								
	Ripple Current	<3%																								
	Channel	1																								
	Current Tolerance	±5%																								
	No load output voltage	50V Max																								
	Turn on delay Time	<1.5s, at230Vac																								
	<table border="1"> <thead> <tr> <th colspan="5">Current Selection Table</th> </tr> <tr> <th>ON</th> <th>OFF</th> <th>1</th> <th>2</th> <th></th> </tr> </thead> <tbody> <tr> <td></td> <td></td> <td>350mA</td> <td>400mA</td> <td>450mA</td> </tr> <tr> <td></td> <td></td> <td>9-40V</td> <td>9-37V</td> <td>9-33V</td> </tr> <tr> <td></td> <td></td> <td></td> <td></td> <td>9-30V</td> </tr> </tbody> </table> <p>Remark: Function default setting is: 350mA (@switch are all OFF state)</p>		Current Selection Table					ON	OFF	1	2				350mA	400mA	450mA			9-40V	9-37V	9-33V				
Current Selection Table																										
ON	OFF	1	2																							
		350mA	400mA	450mA																						
		9-40V	9-37V	9-33V																						
				9-30V																						
Function	Dimming Type	DALI/1-10V active signal/adjustable resistance/PWM/Touch DIM																								
	Priority order	DALI>[1-10V active signal/adjustable resistance/PWM]> Touch DIM																								
Protection	Short Circuit	Close output, recovers automatically after fault removed																								
	Over Load	When the output voltage is exceeded, the output current decreases and, recovers automatically when the load is reduced.																								
	Over Temperature	Shut down the output, recovers automatically when temp. back to normal.																								
Others	Working Temp.	-20°C-50°C																								
	Storage Temp., Humidity	-40°C-85°C, 20-90%RH																								
	tc	90°C																								
	Material	PC																								
	IP Rating	IP20																								
	Lifetime	50,000h@tc:80°C																								
	Warranty Condition	5 Years																								
	Switch Cycle	>100,000 tims																								
	Packing(weight)	Net weight: 125g±5%/PCS; 50PCS/Carton; 6.65kg±5%/Carton; Carton Size: 319*254*136mm(L*W*H)																								
	Dimension	150*43*29mm (L*W*H)																								

Dimension(mm)

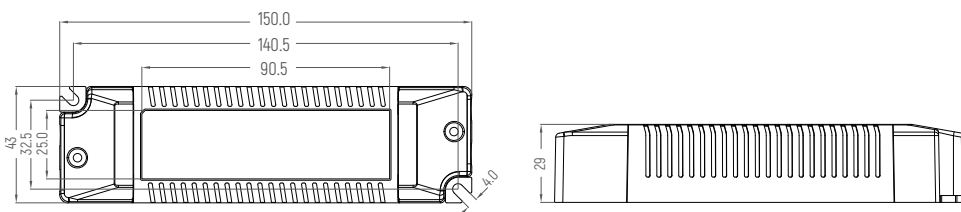

Wiring Diagram

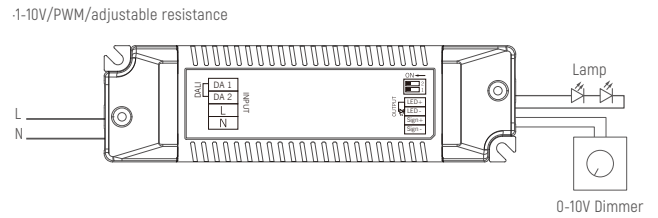
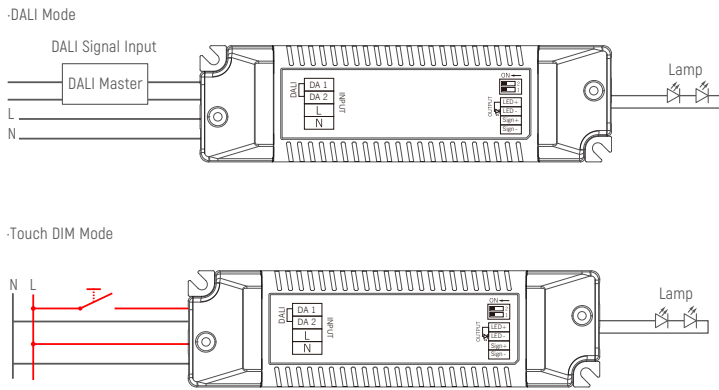

DALI Diagram

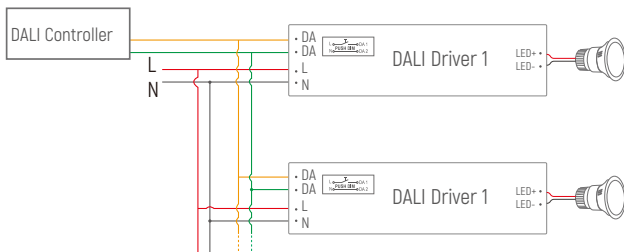

Push DIM(Touch DIM) Diagram

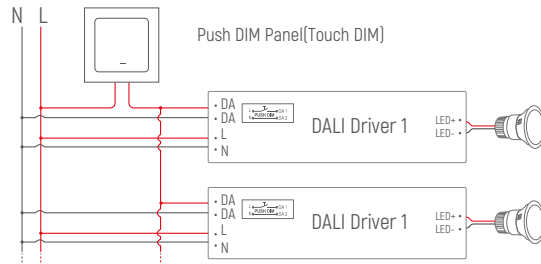

Remark: Only use open push button without indicator light. Maximum cable length between each Unit: 20 meters.

Push DIM Function

1. Short press the Touch DIM switch (<0.5s) to control the lamp on or off.
2. Long press the Touch DIM switch (>0.5s) to dim the brightness of light. The dimming direction will change every time after pressing switch.
3. Double-click the Touch DIM switch (<0.3s), then all lamps connected on the device will be set maximum brightness.
4. The brightness adjustment range is 1%-100%, and the light can be turned off through short pressing when doing the adjustment with long pressing Touch DIM switch.
5. With the Power off memory function, the power-down state will be recovered when power on again.

DALI Dimming Curve

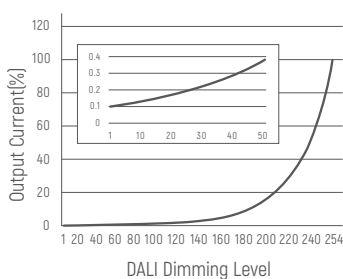

Derating Curve

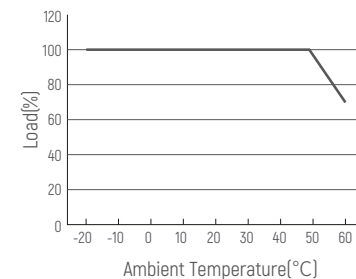

1-10V/PWM/adjustable resistance

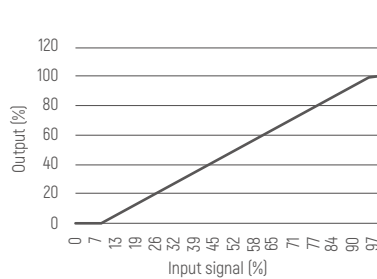

Cautions

- 1.This product should be installed by qualified personnel.
- 2.This product is non waterproof, need to avoid sun and rain.In case of outdoor use, please ensure it is mounted in a water proof enclosure.
- 3.Good heat dissipation conditions extend product life. Please install the product in a well-ventilated environment.
- 4.Please make sure LED power supply output voltage, current is used to meet the product requirements.
- 5.Please ensure that adequate sized cable is used from the controller to the LED lights to carry the current. Please also ensure that the cable is secured tightly in the connector.
- 6.Due to safety concerns, PVC or rubber cord of 0.75- 1.5mm² is recommended for input and output terminal(s)(excluding signal terminals). Flat power cord is not suitable.Ensure all wire connections and polarities are correct before applying power to avoid any damages to the LED lights.
- 7.In case of malfunction, do not repair it yourself.

※ The contents of this manual are updated without prior notice. If the function of the product you are using is inconsistent with the instructions, the function of the product shall prevail.Please contact us if you have any questions .

EUP15AD-1HMC-0 (产品代码:100100071101)

概述

EUP15AD-1HMC-0 是一款可以提供350/400/450/500mA 4档电流的LED驱动器。输出电流可以通过DIP拨码开关简易设置,符合DALI标准协议IEC62386。支持DALI, 1-10V有源信号,可调电阻, PWM, Touch DIM 多种调光方式。曲线平滑、无闪烁。



产品特点

- 单通道恒流输出, 多级电流可选
- 支持多种调光方式 (DALI/1-10V有源信号/可调电阻/PWM/Touch DIM)
- 高电压输入: 220VAC ~ 240VAC
- Class 2电源, 全防护塑胶外壳
- 内建主动式PFC功能
- 短路保护, 过载保护, 过温保护
- 适用于LED室内灯具,比如筒灯, 射灯, 面板灯等



应用



技术参数

型号	EUP15AD-1HMC-0																			
输入	效率	>85%@230VAC, 满载																		
	电压	220VAC-240VAC																		
	频率	50/60Hz																		
	功率因素	≥0.95@230VAC, 满载																		
	THD	<10%@230VAC, 满载																		
	电流	0.08Amax@230VAC																		
	待机功耗	<0.5W																		
	浪涌电流	冷启动,18A(在 50%Ipeak下测twidth=14us)@230VAC																		
输出	电流/电压/功率	350mA/9-40VDC/14W 400mA/9-37VDC/14.8W 450mA/9-33VDC/14.85W 500mA/9-30VDC/15W																		
	波纹电流	<3%																		
	通道	1																		
	电流精度	±5%																		
	空载输出电压	50V Max																		
	启动延时	<1.5s, at230Vac																		
电流选择表																				
<table border="1" style="width: 100%; text-align: center;"> <tr> <td>ON</td> <td>OFF</td> <td>1 2</td> <td>3 4</td> <td>5 6</td> <td>7 8</td> </tr> <tr> <td></td> <td></td> <td>350mA</td> <td>400mA</td> <td>450mA</td> <td>500mA</td> </tr> <tr> <td></td> <td></td> <td>9-40V</td> <td>9-37V</td> <td>9-33V</td> <td>9-30V</td> </tr> </table> <p>备注: 出厂默认设置电流为350mA(12在OFF状态)</p>			ON	OFF	1 2	3 4	5 6	7 8			350mA	400mA	450mA	500mA			9-40V	9-37V	9-33V	9-30V
ON	OFF	1 2	3 4	5 6	7 8															
		350mA	400mA	450mA	500mA															
		9-40V	9-37V	9-33V	9-30V															
功能	调光方式	DALI/1-10V有源信号/可调电阻/PWM/Touch DIM																		
	优先级	DALI > {1-10V有源信号/可调电阻/PWM} > Touch DIM																		
保护	短路	关闭输出, 排除故障后自恢复																		
	过载	打嗝, 移除故障后自恢复																		
	过温	关断输出, 当温度恢复正常时自动恢复																		
其它	工作温度	-20°C-50°C																		
	储存温度、湿度	-40°C-85°C, 20-90%RH																		
	tc	90°C																		
	材质	PC																		
	防水等级	IP20																		
	寿命	50,000小时@tc:80°C																		
	质保	5年																		
	开关周期	>100,000次																		
	包装尺寸(重量)	净重: 125g±5%/PCS; 50PCS/Carton; 6.65kg±5%/箱; 外箱尺寸: 319*254*136cm(长*宽*高)																		
尺寸	150*43*29mm (长*宽*高)																			

尺寸(mm)

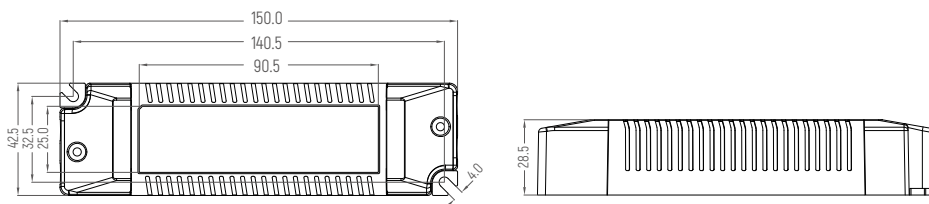

接线图

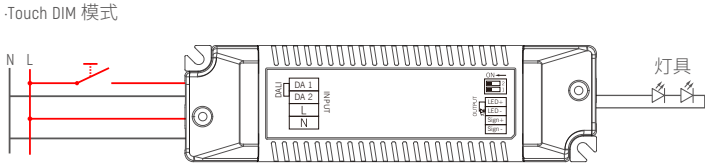
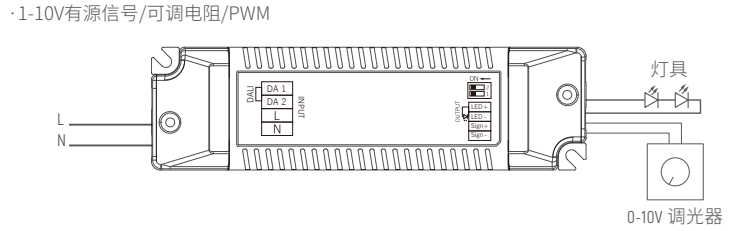
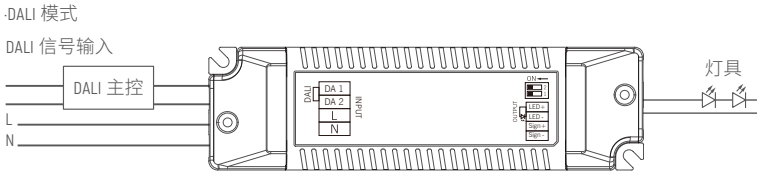

DALI应用图

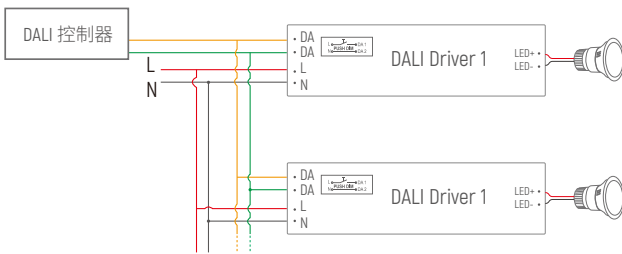

Push DIM (Touch DIM)应用图

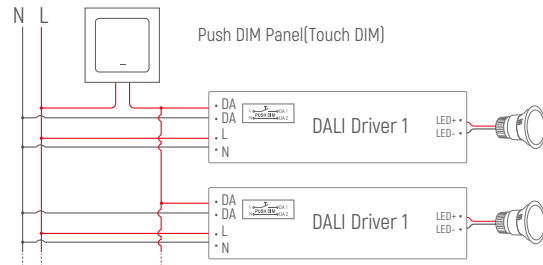

备注: 只能使用开路的按压式开关(不带指示灯). 采用同步连线时每个设备和设备之间的线长不超过20米.

Push DIM 功能

- 1.短按Touch DIM 开关 (<0.5秒) 进行灯的亮暗控制。
- 2.长按Touch DIM 开关 (>0.5秒) 进行灯具的亮度调节, 光是调亮还是调暗, 随着每次按压的开关变化而变换。
- 3.双击Touch DIM 开关 (<0.3秒), 连接的所有灯具将达到最亮状态。
- 4.亮度调节范围为1%-100%。
- 5.具有断电记忆功能, 重新上电将恢复到上一次断电的状态。

DALI调光曲线

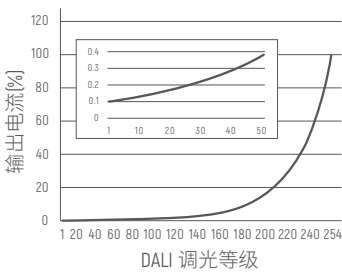

降额曲线

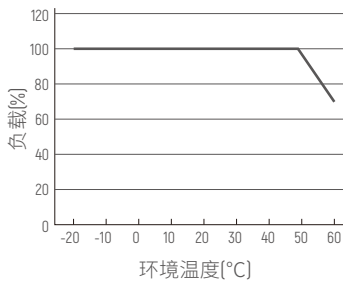

1-10V有源信号/可调电阻/PWM

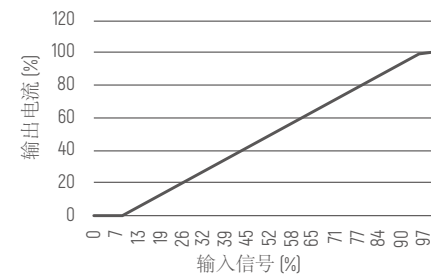

注意事项:

- 1、本产品请由具有专业资格的人员进行调试安装。
- 2、本产品不能防水, 需避免日晒雨淋, 如安装在户外, 请用防水箱。
- 3、良好的散热条件会延长产品的使用寿命, 请把产品安装在通风良好的环境。
- 4、请检查使用的LED电源输出电压电流, 是否符合产品要求。
- 5、出于安全考虑, 推荐输入和输出(信号端除外)用0.75-1.5mm² PVC或橡胶线缆, 并确保接线牢固, 以免电线过热或接触不良触发事故。扁平电源线不适用。
- 6、通电调试前, 应确保所有接线正确, 以避免因接线错误而导致灯具损坏。
- 7、如果发生故障, 请勿私自维修; 如果有疑问, 请联系供应商。

※ 本说明书内容如有更新, 恕不另行通知。若您使用的产品功能与说明书不一致时, 请以产品为准。如有疑问请与我们联系。